

CALEC® ST

Innovative solutions in energy measurement

Applications

The CALEC® ST is an energy totalizer with communication capabilities for critical measuring tasks such as those for:

- Heating plants
- Climatic ceilings and thermally-activated building components and those that can be integrated into heating and cooling systems
- Solar energy plants in apartment blocks and other buildings
- Communication with building management systems



Features

- New: For combined heating/cooling systems
- New: For glycol-based heat carriers
- New: Memory for 60 measurement sets (logger)
- Optional pulsed inputs/outputs
- Battery or mains version
- Optional LON interface, FTT-10A, certified to LONMARK® 3.2
- Freeze function
- Separate, verified plug-in totalizer module

Your benefits

- Heat and cold measurement
- For cold and solar thermal plants
- For monitoring operations
- With expansion modules
- Optimum LON integration
- Simultaneous read-out from the network
- Cost-savings with subsequent verification

Application

The **CALEC® ST** is available as a remote (split) version for energy measuring points fitted with passive pulsed volumetric flowmeters and 2- or 4-wire Pt100 or Pt500 temperature sensors. The CALEC® ST is usually operated with the following flowmeters:

- multijet flowmeters for the range Q_p 0,6 - 10 m³/h
- Woltman flowmeters for the range Q_p 15 - 400 m³/h
- static flowmeters up to Q_p 400 m³/h

Select from our extensive range of flowmeters or simply contact us for more details.

The **CALEC® ST Flow** is a flow totalizer with a similar function but without temperature measurement.

Compulsory calibration and design approval

Energy measuring points are subject to verification in most countries and the equipment used must have design approval. At present, the CALEC® ST is approved to EN 1434-1 for use in those countries shown in the approvals section (page 11).

Heat meters for commercial use must be verified again before their present certificate expires. The operator is responsible for this subsequent verification. Verification includes all components of a composite heat meter (sensors, flowmeter, totalizer).

At present, design approval may only be given for water as the heat carrier medium and for simply heat or cooling operations.

Because of administrative reasons design approval cannot be given for some functions including

- operation with glycol-based heat carriers
- combined heating/cooling operations
- low flow cut-off,

that means that these functions may not be used in custody transfer.

Standard applications and measuring principle

The following individual verified elements are required for a composite heat meter:

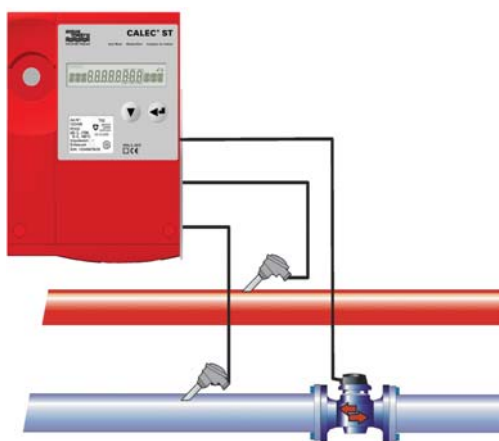

- 1 pair of temperature sensors
- 1 flowmeter with pulse signal transmitter
- 1 transformer (totalizer).

The thermal power P released in a piping network is derived from the measuring of flow pipe temperature, return pipe temperature and mass flow of the carrier medium.

$$P = \text{specific heat } (T_m, \text{medium}) * \text{density } (T_m, \text{medium}) * (T_{\text{hot}} - T_{\text{cold}})$$

T_{hot} : higher temperature, with heated flow temperature
 T_{cold} : lower temperature, with heated return temperature
 T_m : mean temperature = $(T_{\text{hot}} - T_{\text{cold}})/2$

Energy can be calculated with respect to power. The equation shows that, for energy measurement, the specific heat and the density of the heat carrier must be calculated as a function of the temperature in the totalizer. The factors on which measurement accuracy depend include:

- the static accuracy and stability of temperature measurement
- the totalizer period for temperature measurement and the flowrate for determining dynamic processes

CALEC® ST is especially equipped for demanding measurement duties with its

- high-resolution and long-term stable 16 bit AD converter for temperature measurement and an integrated self-calibration and filter function
- rapid totalizer clock (mains version 1 s)
- optional high-resolution mechanical or electrical flow transmitter with a pulse frequency up to 200 Hz (mains version).

Energy measurement in heating/cooling plants

The optional "bi-directional energy measurement" (BDE) enables energy released to also be measured in two-pipe networks in combined heating/cooling operations. The hot and cold measured values are determined in separate registers so that they can be invoiced at the appropriate rates.

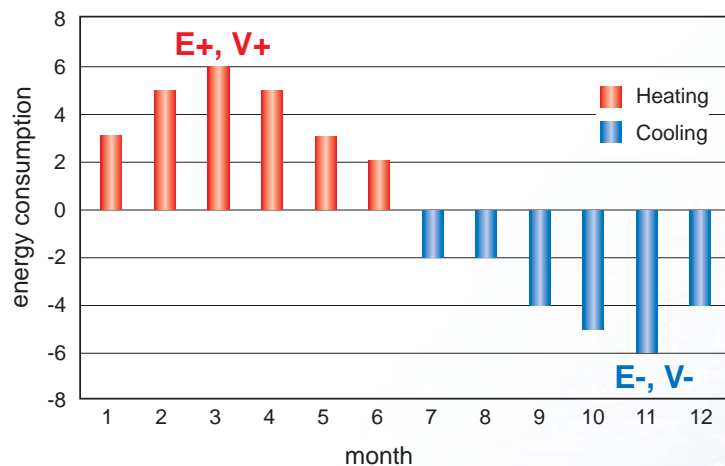

Cold plants

Below freezing temperatures in cold plants require the use of antifreeze. Standard heat meters are thus faced with many insuperable problems such as those examined in detail in the PTB report PTB-ThEx 24 dated June 2002.

With its "glycol based heat carrier" (GLY) option, CALEC® ST can therefore also carry out precision measurement in such cases. This is because, with its sliding values of temperature-dependent density and heat capacity, the energy and mass can be calculated for every temperature. CALEC® ST calculates the exact values with polynomials of the seven most common heat carriers as a function of concentration and temperature (as shown in the table below).

Only the type of heat carrier and its concentration need to be defined when commissioning (as shown in the table below):

Medium ⁴⁾	Display	Concentration	Temperature range	Manufacturer	Type	Application/remarks
Antifrogen N	AntifroN	20% - 60%	- 120°C ¹⁾	Clariant	E ²⁾	Complies with DIN 4757-1; poison type 4 For cooling, solar, heating and thermal pump plants Low viscosity requires smaller pumping capacities
Antifrogen L	AntifroL	20% - 60%	- 120°C ¹⁾	Clariant	P ³⁾	Completely safe, Pharmaceuticals, foodstuffs
Tyfoacor	Tyfoacor	20% - 60%	- 120°C ¹⁾	Tyfoacor	E	See Type E
Tyfoacor-L	TyfoacorL	20% - 60%	- 120°C ¹⁾	Chemie	P	See Type P
DowCal 10	DOUCAL10	30% - 70%	- 120°C ¹⁾	Dow	E	See Type E
DowCal 20	DOUCAL20	30% - 70%	- 120°C ¹⁾	Dow	E	See Type E
Glythermin P44	GLYTHP44	40% - 80%	- 100°C ¹⁾	BASF	P	FDA approval in USA, corrosion-protection less effective For pharmaceuticals and foodstuffs plants

- 1) Minimum temperature depends on concentration -40...0 °C
- 2) Based on ethylene glycol
- 3) Based on propylene glycol
- 4) The names are registered trade marks of the companies mentioned.

The following graphs give examples showing that the temperature dependence of specific heats and densities significantly affects the calculation.

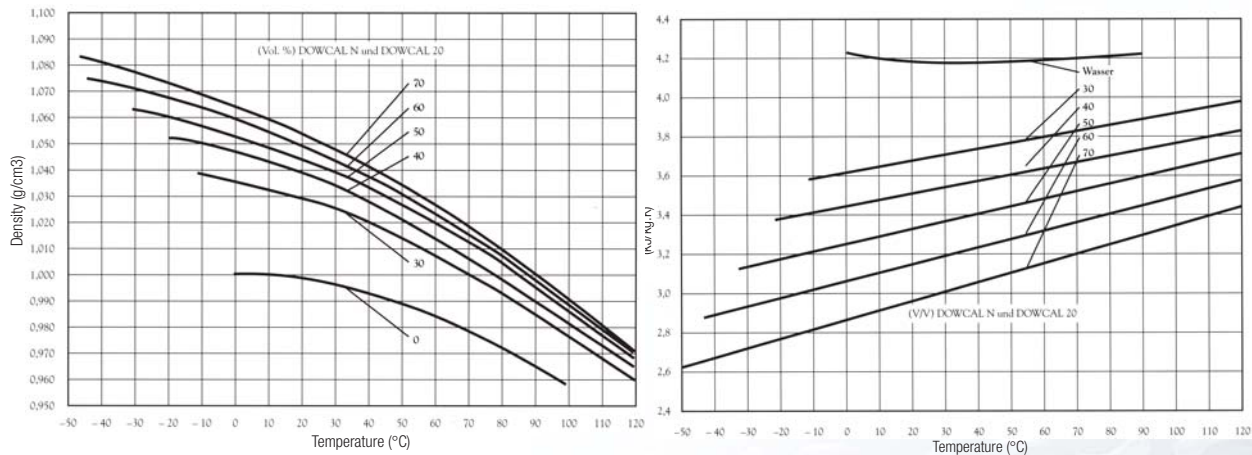

DOWCAL is a registered trade mark of Dow Chemical

Solar plants

Temperature range and the heat carrier used greatly affect energy measurement in solar plants.

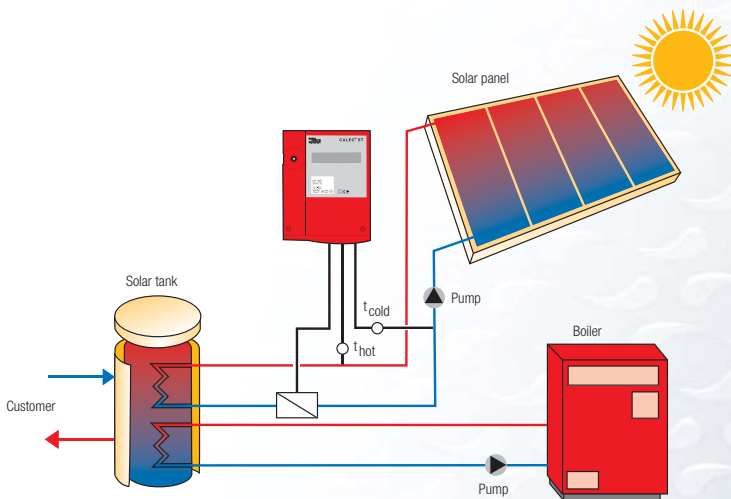

AWith its optional **"glycol-based heat carrier"** GLY, CALEC® ST is the ideal solution for this application (see also the section on cold plants).

Communication

M-Bus

The outstanding characteristics of the M-Bus and its standardization to EN 1434-3 ensure:

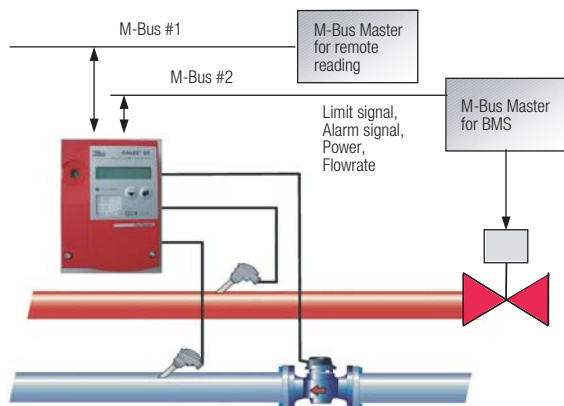

- simple installation
- cost savings
- compatibility to multinational suppliers

These make it the ideal choice for building management systems everywhere.

The CALEC® ST can therefore be equipped with up to 2 M-Bus interfaces.

Not only standard data, such as meter readings and actual measurement values are read, but also additional data such as billing dates and values in the memory can be called up via M Bus interfaces.

The primary address and baud rate can be set using the keys on the CALEC® ST so that start-up can be done without a PC.

The Freeze function (see also page 7) also ensures values can be simultaneously read in extensive M-Bus networks subject to long time delays.

The M bus is a single master bus and only a slave bus can therefore communicate with it. If another device for remote reading is to transmit data to another M-Bus master used in the building management system, then this can only be done with devices fitted with two M-Bus interfaces. For this, the CALEC® ST can be fitted with a second M-Bus interface.

The LON interface

Unlike M-Bus systems, a Local Operating Network enables the functions of the building management system to be integrated with the meter readings into a single system. The Local Operating Network (LON) is a multimaster system with intelligent nodes which can use different signal carriers. A LON interface card (FTT-10 A) is available for the CALEC® ST to transmit over two wires (twisted pair). One outstanding feature of LON technology is its interoperability, which ensures that the lifetime of the building management system exceeds that of any of its individual components. The CALEC® ST is the first energy totalizer to be certified according to LONMARK® 3.2 so that interoperability is no longer an empty promise. This means smooth integration into a LON along with savings of time and money. The commissioning procedure also means that there are no nasty surprises or uncertainties with billing. The LonMark certificate also ensures:

- data objects of the network node are in the object library of integration tools (e.g. LonMaker) and can easily be used
- signals and interfaces are fully defined in the External Interface File (XIF) so that the system function can be programmed offline, (i.e. without peripherals).
- CALEC® ST has the total functionality of a LON node, including diagnosis and installation help functions such as the service LED and service key.
- allocating nodes to data points can be carried out using the identification number of the neuron chip: the NeuronID. An adhesive label with the NeuronID as a bar code is enclosed with the device. Installation personnel can stick the label onto the appropriate area of the plan after assembly. This ensures that the integration specialist can record this and assign data at the work desk using a bar code reader.

The NOWA interface

The CALEC® ST can be checked on neutral NOWA test beds using a suitable software interface.

Digital input and outputs

The CALEC® ST can be equipped with two digital signal interfaces that can be switched to inputs or outputs. These signals can be used to provide counting pulses or to transmit limit violations or alarms to the building management system.

Limit signals

The digital output signals can be used for transmitting a limit value monitoring signal. The following parameters can thus be monitored:

Parameter	Display
Temperature, hot side	t-hot
Temperature, cold side	t-cold
Temperature difference	t-diff
Power	POUEr
Flow	FLOU
C-factor	C-Factor
Density	dEnSitY

1. Single limit monitoring (Limit 1)

The output signal changes once a value moves outside a preset maximum **or** minimum level; hysteresis (0-10 %) and action can be selected as required. For control purposes, the length of time of the violation the limit value is totaled in the device (display: Cnt for Counter).

2. Double limit monitoring (Limit 2)

The operation is identical to Limit 1 **and** is activated once a value moves outside a preset maximum and minimum.

Alarm

The microprocessor monitors the temperature sensors and internal functions as well as indicates errors, which are shown on the display. This information can also be transmitted as an alarm via a digital output.

Additional functions

Billing dates

With two freely-programmable billing dates, meter readings can be accurately stored between the two dates and read out at any time, e.g. on 31 March and 30 September.

Data logger

The CALEC® ST allows up to 60 data sets to be periodically stored in a ring memory.

Parameter	Display
Date	Total
Energy	Total
Volume	Total
Aux. counter 1	Total
Aux. counter 2	Total
Power	Peak value
Downtimes in hours	Total

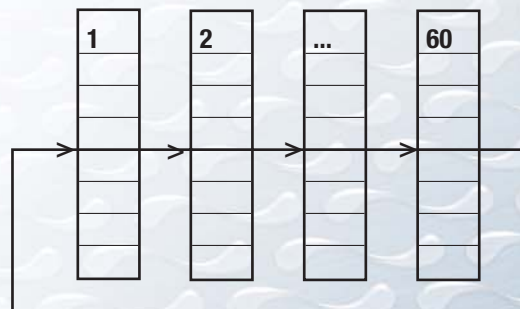

Simultaneous readings with the M-Bus and LON (Freeze)

Because of the long delay times that can occur with communication, it may not be possible to have simultaneous read-out of several meters using a meter bus system.

The Freeze function of the CALEC® ST is the ideal solution for this. Using a broadcast command, all devices simultaneously store all their current measurements. These can then be read out one after the other. This Freeze function is available for both the M-Bus and the LON.

Low flow cut off

When first operated, the meter is set up to carry out energy calculations as soon as there is a temperature difference of > 0 (for heat measurement) or < 0 (for cold measurement). For example, if large amounts of the heat carrier medium are flowing where there is a very low temperature difference, the error resulting from temperature measurement can be quite significant. To prevent this, the CALEC® ST can activate the low flow cut off function so that the energy is only determined once a defined temperature difference is detected (with no verified measuring points only).

Operation

All settings on the CALEC® ST can be made on the instrument itself in a logical sequence without the need of peripheral equipment.

Multifunction display

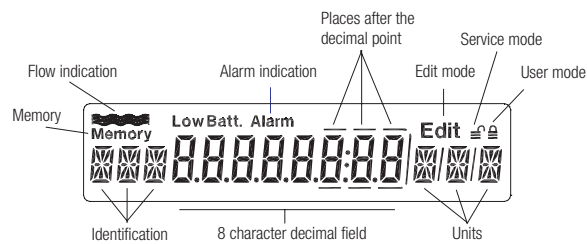

Meter readings with up to 8 numerical characters, symbols and short texts can be shown on the multifunction display as an interactive process guide.



The displays can be selected by pressing two keys when the housing is closed and the device is in operation:



The service key is located under the cover and protected by a leaded seal. Pressing this key enables additional service information to be displayed and settings made:

The following diagram shows all the necessary information required in the main flow loop with short texts given in the sub-loops :

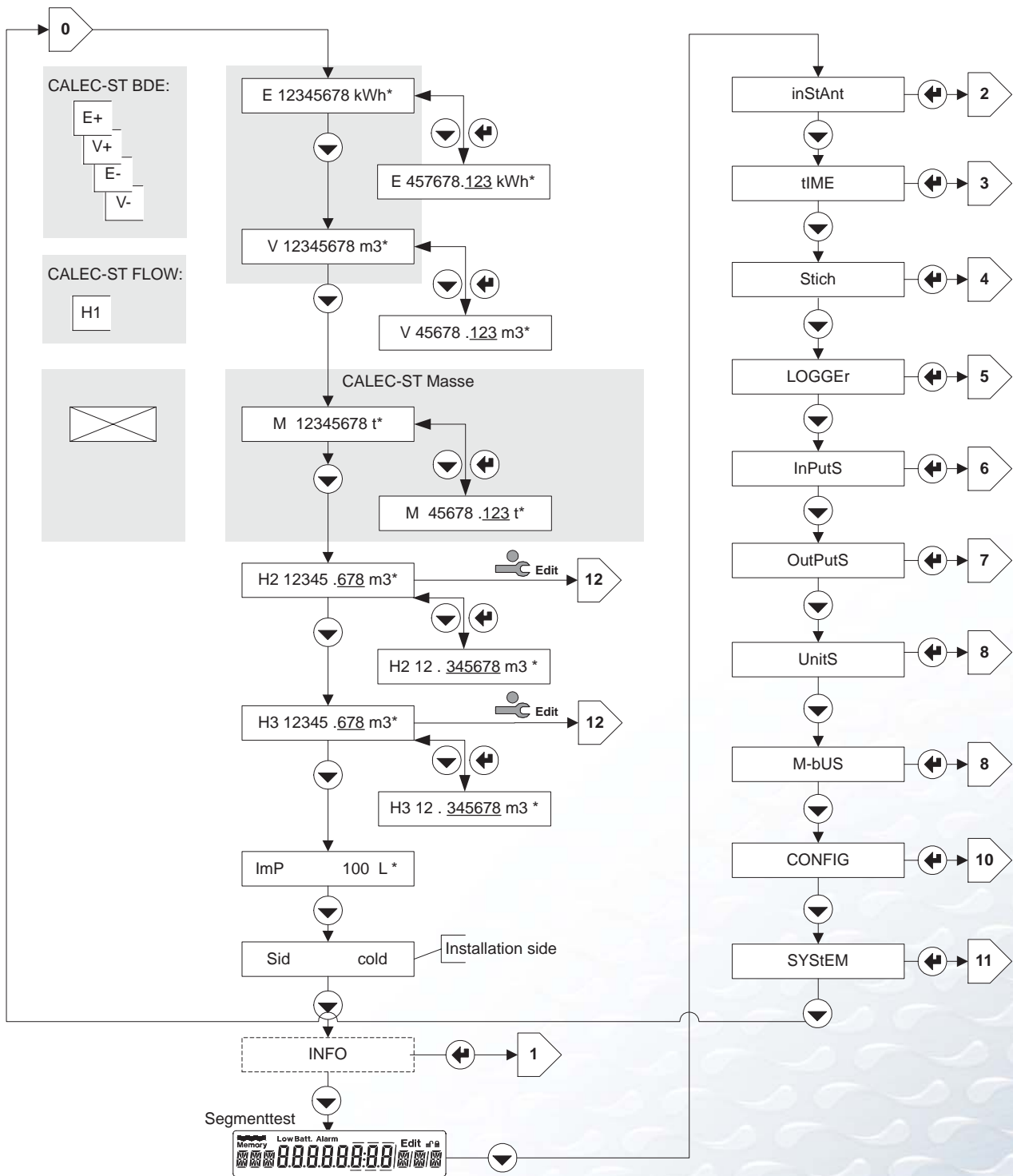

Display:	Description:
Info:	Error message
InstAnt:	Actual values, temperature, power, flowrate, C-factor, density
Time:	Date and time
Stich:	Billing date
LoGGEr:	Data logger memory values
InPutS:	Settings and status of signal inputs
OutPutS:	Settings and status of signal outputs
UnitS:	Setting of units
M-bUS:	M-Bus settings
CONFIG:	Other settings, e.g. for glycol-based heat carriers
SYStem:	System data, e.g. firmware version

Plug-in meter module

The energy meter is inside a plug-in computer module. The lower section of the housing and its wiring must not be removed. In addition, all device-specific data remain in the configuration memory (EEPROM) in the lower section of the housing (except for verified parameters such as pulse value and installation side).

Housing dimensions

Housing

Lower section with connecting terminals, computer module and cover.

Assembly

DIN rail or 3-point fastening directly to the wall.

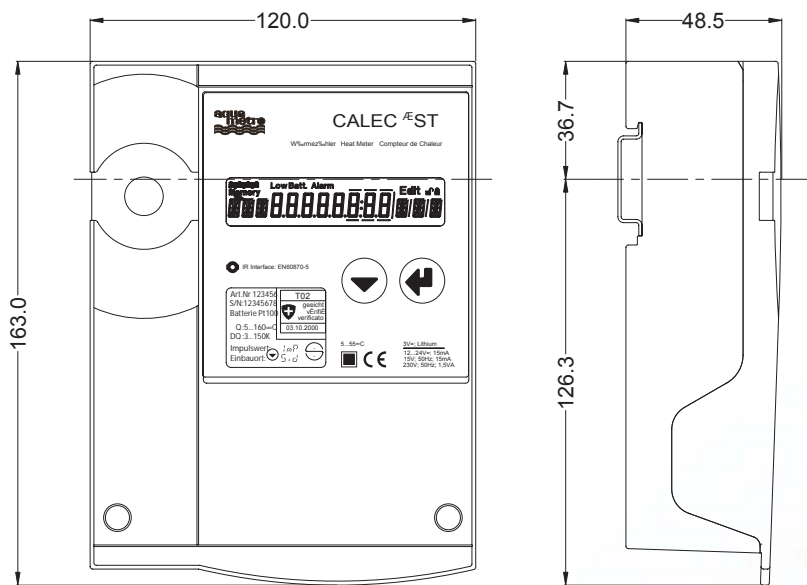

Electrical connections

The wiring plan depends on the instrument version and its specific options. A wiring plan of the instrument on delivery is on the inside of the housing cover.

Battery version

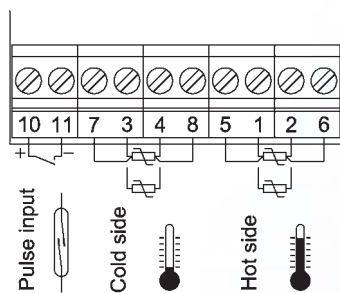

Mains version

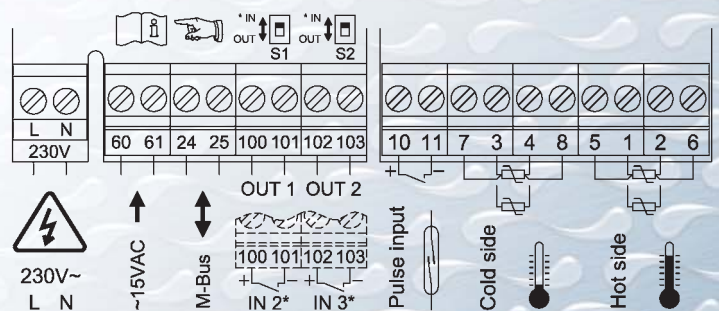

Technical specifications and standards

Standards	
Directive for CE conformity	Directive 89/336/EWG, 92/31/EWG, 93/68/EWG Electromagnetic compatibility (EMC)
Standards	EN 1434 heat meters EN 55081-1 electromagnetic compatibility EN 50082-2 electromagnetic compatibility
Housing and operating conditions	
Dimensions	BxHxD =
Ambient temperature	+5 ... +55 °C, EN 1434 Class C
Storage temperature	0 °C ... 60 °C
Visual interface	Complies with IEC 870-5, M-Bus protocol
Measurement	
Temperature range	0 ... +170 °C Design approval 5 °C ... 160 °C
Temperature differential	0 ... 170 K Design approval 3 K ... 150 K
Temperature sensors	Pt100 or Pt500 acc. to IEC, paired, as 2 or 4-wire connection
Installation side	Hot or cold, cold side preferred for heating, hot side for preferred for cooling
Pulse value for volume	0.001 ml to 9999.999 m ³
Pulse value for energy	0.001 kWh to 9999.999 GJ oder 0.001 KBtu to 9999.999 MBtu
Error limits	Better than EN 1434-1 for totalizer. Suitable for composite heat meters of Class 2 acc. to EN 1434-1 when using suitable flowmeters
Display	
Units for volume	m ³ , USGal
Units for energy	KWh, MWh, MJ, GJ, KBtu, MBtu
Backup on mains failure	In EEPROM > 10 years
Memory	60 data sets, scanning 1 x per month, per 2 days, per day (also every hour with mains version)
Additional functions	
Additional functions	Energy calculation is suppressed as long as the difference dT is < 3K
No flow cut off	One-way or two-way, hysteresis 0-10 %, selectable mode of output signal

Battery version	
Power supply	3 V lithium batteries, operating life > 6 years, if ambient temperature < 45 °C
Totalizer cycle	20 s
Flow input	Potential-free contact, pulse ≥ 8 ms, max. 10 Hz with symmetrical pulse signal, max. 6 Hz

Mains version	
Power supply	230 V AC, 50/60 Hz, approx. 7 mA, ca. 0.35 VA 12 ... 24 V DC or 15 V AC
Totalizer cycle	1 s
Internal batteries	3 V Li round cell
Pulse input for flow	NAMUR/transistor: pulse > 0.35 ms, pause > 2.5 ms, max. 200 Hz 8 V / 1 kW, switchpoint 1.5 / 2.1 mA Contact max. 20 Hz with symmetrical pulse

Options	
Output board	2 transistor outputs, max. 48 VDC 50 mA
M-Bus board #1	M-Bus interface acc. to EN 1434-3, 300 and 2400 baud Power supply of interface via M-Bus 2 configurable switch transistor inputs or outputs Outputs: Semiconductor relay, max. 48 V AC/DC max. 50 mA Inputs for potential-free contact or transistor signal transmitter Max. 6 Hz with symmetrical pulse signal
M-Bus board #2	As above, but without in/outputs
LON board FTT	FTT-10A, free topology (2 wire twisted pair), certified acc. to LonMark 2.3 Transmission rate 78 kBaud Max. bus length: 500 m/2700 m without/ with terminating resistors 64 nodes per segment 2 configurable switch transistor inputs or outputs Outputs: Semiconductor relay, max. 48 V AC/DC max. 50 mA Inputs for potential-free contact or transistor signal transmitter Max. 10 Hz with pulse ≥ 8 ms pause ≥ 80 ms Max. 6 Hz with symmetrical pulse signal

Approvals

Certifications to EN 1434-1:

Germany (PTB) 22.55/01.02

Switzerland (metas) T2/725

Other countries on request.

Instrument versions

CALEC® ST Energy

Battery version Options				Sensors	Article No.	
Communication	Power for communication module	2 transistor outputs	2 NAMUR pulse inputs or 2 relay outputs	Pt 100 Pt 500	Totalizer	Expansion module
		-		•	92400	
		-		•	92401	
		•		•	92400	92434
		•		•	92401	92434
M-Bus	Battery		•	•	92400	92435
	Battery		•	•	92401	92435
LON FTT-10 A	230 VAC*)		•	•	92400	92481
	230 VAC*)		•	•	92401	92481
	12-24 VAC, 12-42 VDC		•	•	92400	92500
	12-24 VAC, 12-42 VDC		•	•	92401	92500

Mains version				Sensors		Article-No.	
Options				Pt 100	Pt 500	Totalizer	Expansion module
Communication	Power for communication module	2 transistor outputs	2 NAMUR pulse inputs or 2 relay outputs				
M-Bus	230 VAC, 15 VAC		•	•	92402	92499	
	230 VAC, 15 VAC		•	•	92403	92499	
LON FTT-10 A	230 VAC*)		•	•	92402	92481	
	230 VAC*)		•	•	92403	92481	
	12-24 VAC, 12-42 VDC		•	•	92402	92500	
	12-24 VAC, 12-42 VDC		•	•	92403	92500	

CALEC® ST Flow

Battery version				Article-No.	
Options				Totalizer	Expansion module
Communication	Power for communication module	2 transistor outputs	2 NAMUR pulse inputs or 2 relay outputs		
		-		92525	
		•		92525	92434
M-Bus	Battery	•		92525	92435
LON FTT-10 A	230 VAC*)		•	92525	92481
	12-24 VAC, 12-42 VDC		•	92525	92500

Mains version				Article-No.	
Options				Totalizer	Expansion module
Communication	Power for communication module	2 transistor outputs	2 NAMUR pulse inputs or 2 relay outputs		
M-Bus	230 VAC, 15 VAC		•	92465	92499
LON FTT-10 A	230 VAC*)		•	92465	92481
	12-24 VAC, 12-42 VDC		•	92465	92500

*) can also be operated with a 12 – 24 VAC or 12 – 42 VDC power supply

Accessories

Description	Version	Article No.
Reading head	OCI 9600	83376
Mounting rail	DIN rail	19838
CALEC® ST		